



TTP Energy

- MOUNTING
- WALK WAY
- PERFORATED TRAY
 - CABLE TRAY
 - CABLE LADDER

MOUNTING
อุปกรณ์ติดตั้งโซลาร์เซลล์

2-6

7-8

WALK WAY
ทางเดินโซลาร์เซลล์

SOLAR CELL LIGHT RAIL
อุปกรณ์รางไฟ

9-15

MOUNTING

อุปกรณ์ติดตั้งโซลาร์เซลล์

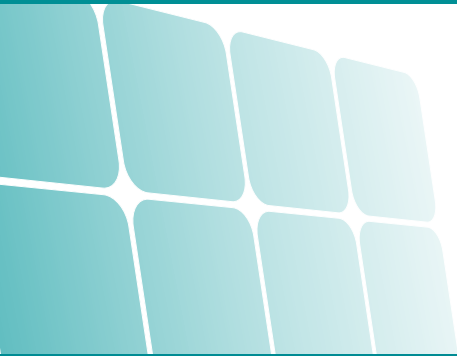



ROOF HOOK KLIP LOCK #650 (แบบจีบB)

STP-M AS-RHKL-01

Specification

- Suitable for : Pitched roof
- Roof slope : up to 60 degree
- Module orientation : landscape or portrait
- Material : Anodized aluminum 20 um & SUS 304
- Standard Loading (N) 14-20
- Anodized AL6063-T5

Detail

- Anodized aluminum : Klip Lock #650
- Stainless Steel : Socket Head Screw M8x25
- Stainless Steel : Nylon Lock Nut M8
- Stainless Steel : Spring Washer M8
- Dimension : W25xH58 mm.
- Weight Total : 135 g.



ROOF HOOK KLIP LOCK #700 (แบบโค้งB)

STP-M AS-RHKL-02

Specification

- Suitable for : Pitched roof
- Roof slope : up to 60 degree
- Module orientation : landscape or portrait
- Material : Anodized aluminum 20 um & SUS 304
- Standard Loading (N) 14-20
- Anodized AL6063-T5

Detail

- Anodized aluminum : Klip Lock #700 + With Rubber
- Stainless Steel : Socket Head Screw M8x25
- Stainless Steel : Nylon Lock Nut M8
- Stainless Steel : Spring Washer M8
- Dimension : W37xH63.5 mm.
- Weight Total : 155 g.



MID CLAMP 35MM (M8x45 MM.)

STP-M MT-MCSW35

Specification

- Suitable for : Pitched roof
- Roof slope : up to 60 degree
- Module orientation : landscape or portrait
- Material : Anodized aluminum 20 um & SUS 304
- Standard Loading (N) 14-20
- Anodized AL6063-T5

Detail

- Stainless Steel : Socket Head Screw M8x45
- Stainless Steel : T Nut Lock M8
- Stainless Steel : Spring Washer M8
- Stainless Steel : Flat Washer M8
- Dimension : W45xD40 mm.
- Weight Total : 54 g.



EARTHING KIT

STP-M AS -EK

Specification

- Suitable for : Pitched roof
- Roof slope : up to 60 degree
- Module orientation : landscape or portrait
- Material : Anodized aluminum 20 um & SUS 304
- Standard Loading (N) 14-20
- Anodized AL6063-T5

Detail

- Stainless Steel : Socket Head Screw M8x25
- Stainless Steel : T Nut Lock M8
- Stainless Steel : Spring Washer M8
- Stainless Steel : Flat Washer M8
- Stainless Steel : Hex Bolt M5x15
- Dimension : W20xL45 mm.
- Weight Total : 41 g.

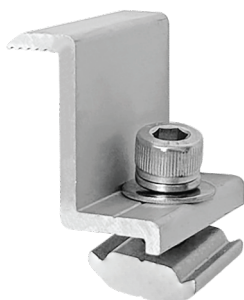

END CLAMP 30/35 MM

STP-M MT-ECA-H35

Specification

- Suitable for : Pitched roof
- Roof slope : up to 60 degree
- Module orientation : landscape or portrait
- Material : Anodized aluminum 20 um & SUS 304
- Standard Loading (N) 14-20
- Anodized AL6063-T5

Detail

- Stainless Steel : Socket Head Screw M8x25
- Stainless Steel : T Nut Lock M8
- Stainless Steel : Spring Washer M8
- Stainless Steel : Flat Washer M8
- Dimension : W40xH30/35 mm.
- Weight Total : 45 g.



SOLAR SUS304 TILE HOOK M10-200

STP-M MT-THM 10-200

Specification

- Suitable for : Pitched roof
- Roof slope : up to 60 degree
- Module orientation : landscape or portrait
- Material : Anodized aluminum 20 um & SUS 304
- Standard Loading (N) 14-20
- Anodized AL6063-T5

Detail

- Stainless Steel : Hanger Bolt M10x200
- Stainless Steel : T Nut Lock M8t
- Stainless Steel : Spring Washer M8
- Stainless Steel : Flat Washer M8
- Dimension : L Feet L40 x H85 x 8.5 mm
- Weight Total : 224g.



SOLAR ALUMINUM HOOK METAL SHEET

STP-M MT-AHMS

Specification

- Suitable for : Pitched roof
- Roof slope : up to 60 degree
- Module orientation : landscape or portrait
- Material : Anodized aluminum 20 um & SUS 304
- Standard Loading (N) 14-20
- Anodized AL6063-T5

Detail

- Stainless Steel : Socket Head Screw M8x25
- Self Drilling Screw Hex Washer + With Rubber
- Stainless Steel : T Nut Lock M8
- Stainless Steel : Spring Washer M8
- Stainless Steel : Flat Washer M8
- Dimension : L Feet L35 x H85 x 8.5 mm
- Weight Total : 118 g.



SOLAR L-BACKING H 16 CM

SSTP-GMT-L-BK9-H16

Specification

- Suitable for : Pitched roof
- Roof slope : up to 60 degree
- Module orientation : landscape or portrait
- Material : Anodized aluminum 20 um & SUS 304
- Standard Loading (N) 14-20
- Anodized AL6063-T5

Detail

- Dimension : W40xH160 mm.
- Weight Total : 54g.



SOLAR SUS304 TILE HOOK/CPAC

STP-M MT-TH/CPAC

Specification

- Suitable for : Pitched roof
- Roof slope : up to 60 degree
- Module orientation : landscape or portrait
- Material : Anodized aluminum 20 um & SUS 304
- Standard Loading (N) 14-20
- Stainless Steel 304

Detail

- Stainless Steel : Socket Head Screw M8x20
- Self Drilling Screw Hex Washer + With Rubber
- Stainless Steel : T Nut Lock M8
- Stainless Steel : Spring Washer M8
- Stainless Steel : Flat Washer M8
- Dimension : 54.8x102.2x162.7 mm
- Weight Total : 567 g.



T NUT WITH BOLT FOR HOOK 15/20/25/60

STP-M MT-TNBH

Specification

- Material : Stainless Steel 304

Detail

- Stainless Steel : Socket Head Screw M8x15/20/25/60
- Stainless Steel : T Nut Lock M8
- Stainless Steel : Spring Washer M8
- Stainless Steel : Flat Washer M8
- Weight Total : 12/15/17/28 g.



RAIL JOINER SPLCE KIT

STP-M MT-JSK180

Specification

- Suitable for : Pitched roof
- Roof slope : up to 60 degree
- Module orientation : landscape or portrait
- Material : Anodized aluminum 20 um & SUS 304
- Standard Loading (N) 14-20
- Anodized AL6063 -T5

Detail

- Stainless Steel : Socket Head Screw M8x15
- Stainless Steel : Flat Washer M8
- Stainless Steel : Spring Washer M8
- Dimension : W54.8 x H10 x L180 mm.
- Weight Total : 134 g.



SOLAR ALU STANDARD RAIL 4200 MM

STP-F AL -260054200-2

Specification

- Material : Anodized AL6063-T5

Detail

- General Thickness : 1.00 mm
- Dimension : W30 x H58.5 x L4200 mm.
- Weight Total : 2.87 kg.



SOLAR ALU STANDARD RAIL 4200 MM

STP-F AL -260054200-3

Specification

- Material : Anodized AL6063-T5

Detail

- General Thickness : 1.00 mm
- Dimension : W25 x H45 x L4200 mm.
- Weight Total : 2.05 kg.



GROUND STAINLESS PLATE FIX

STP-F GS-GC

Specification

- Material : Stainless Steel 304

Detail

- Dimension : W30 x L32 mm.
- Weight Total : 2.5 g.



CABLE CLIP LOCK

STP-F CBCL

Specification

- Material : Stainless Steel 304

Detail

- Dimension : W18 x L22 x H10 mm.
- Weight Total : 4 g.



ALUMINIUM FERRULE 6MM./ 8MM.

STA-F ALU FERRULE8



STAINLESS STEEL WIRE ROPE THIMBLE 6MM./ 8MM.

STP-F SWT-8



STAINLESS STEEL WIRE ROPE CLIP 6MM./ 8MM.

STP-F SWC-8



STAINLESS STEEL TURNBUCKLES 6MM./ 8MM.

STP-F TBG-SIZE 8 mm

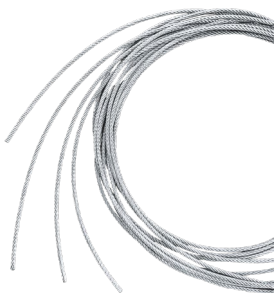

STAINLESS STEEL WIRE ROPE 6MM./ 8MM.

STP-F SWR-8



LIFELINE SAFETY STEEL POLE 1000X30 MM. BASE 500X30 MM.HDG & STAINLESS STEEL 304 (UP TO YOU TO ORDER THE SIZE)

STP-M LLS 100030x50030HDG

WALK WAY

ทางเดินโซล่าเซลล์

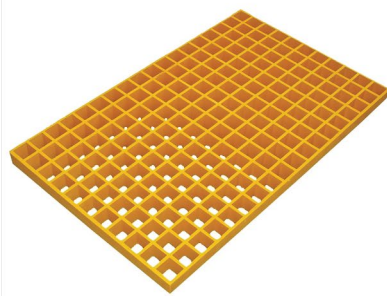

WALK WAY ทางเดินโซล่าเซลล์

แผงตะแกรงขึ้นรูปไฟเบอร์กลาส Fiber Mode Grating Panel พลาสติกไฟเบอร์ ผลิตด้วยกระบวนการขึ้นรูปพิเศษ ด้วยแม่พิมพ์ทำจากเรซินโพลีเอสเตอร์ไม่อิ่มตัว ไวนิลเอสเตอร์และฟอนอลิก วัสดุรูปจากเป็นเมทริกซ์ทำด้วยแก้วที่มี ฤทธิ์ต้านปานกลาง ไปจนถึงปราศจากด่าง แข็งแรง ทนทานต่อทุกสภาพอากาศ

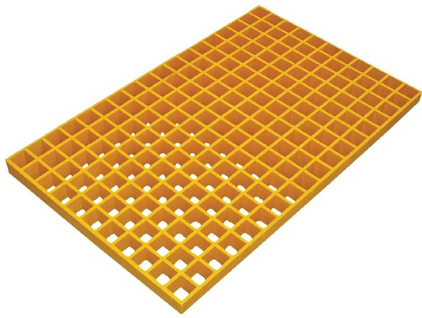

WALK WAY FIBERGLASS

STP-F WFG

Detail

- Materrail : Fiber mode grating panel
- Dimension : 390x25x4020 mm.



WALKWAY CLAMP LOCK M-CLIP M8x25MM

STP-M WCL-M CL M8x25MM

Detail

- Materrail : Stainless Steel 304W50 x H20 mm.
- Dimension : W50 x H20 mm.
- Weight Total : 120 g.



WALKWAY CLAMP LOCK C-CLIP M8x30MM

STP-M WCL-C CL M8x30MM

Detail

- Materrail : Stainless Steel 304
- Dimension : W35 x H30 mm.
- Weight Total : 119 g.

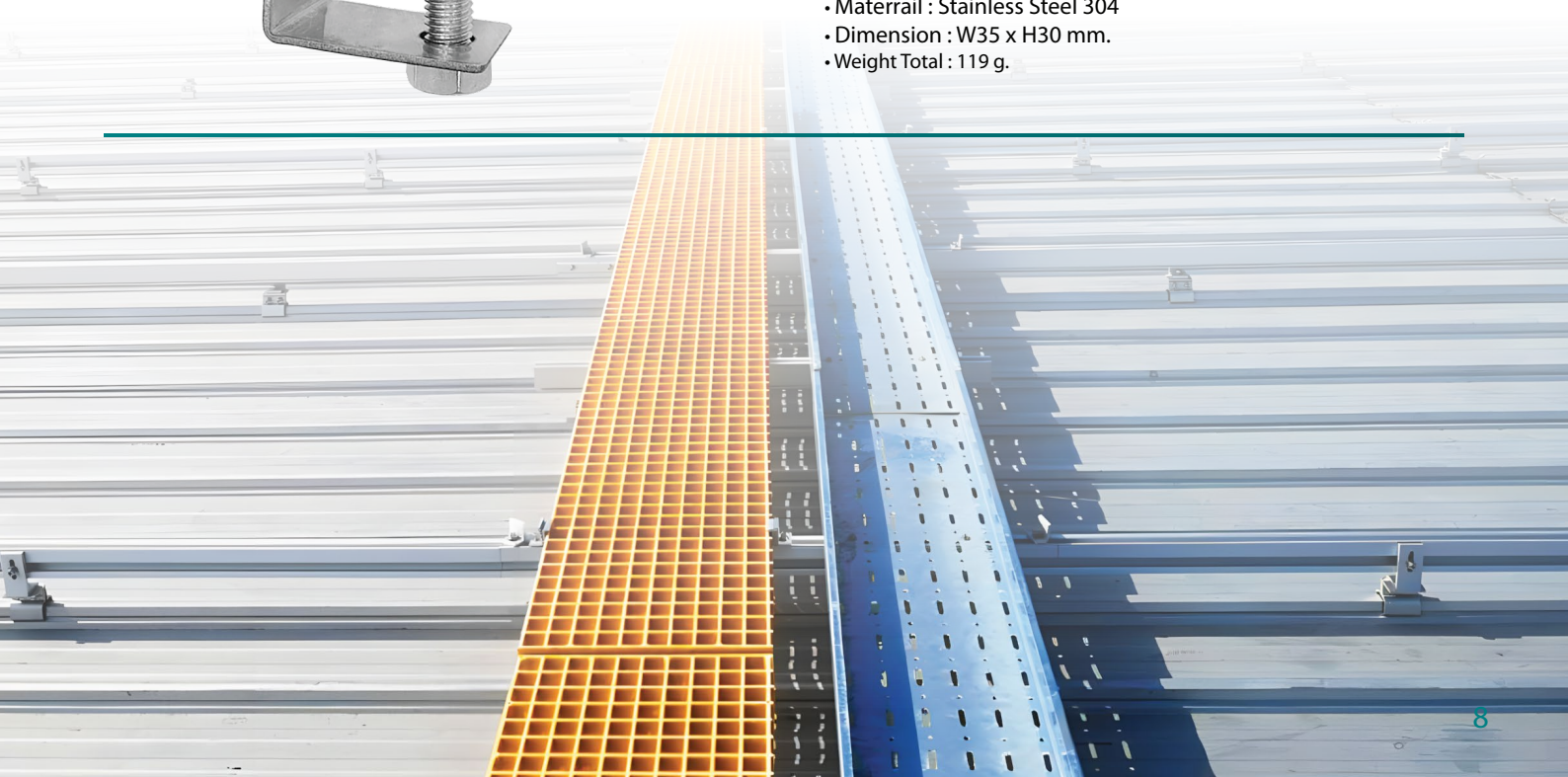

SOLAR CELL LIGHT RAIL

อุปกรณ์รางไฟ

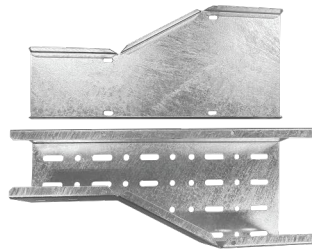
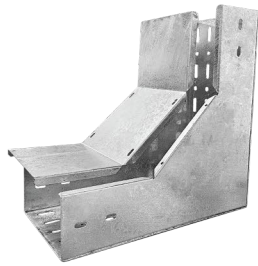
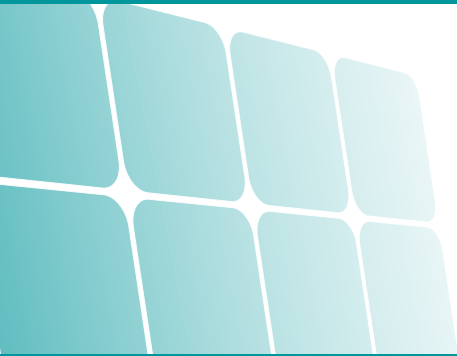

PERFORATED TRAY ອຸປະກອນຮາງໄຟ

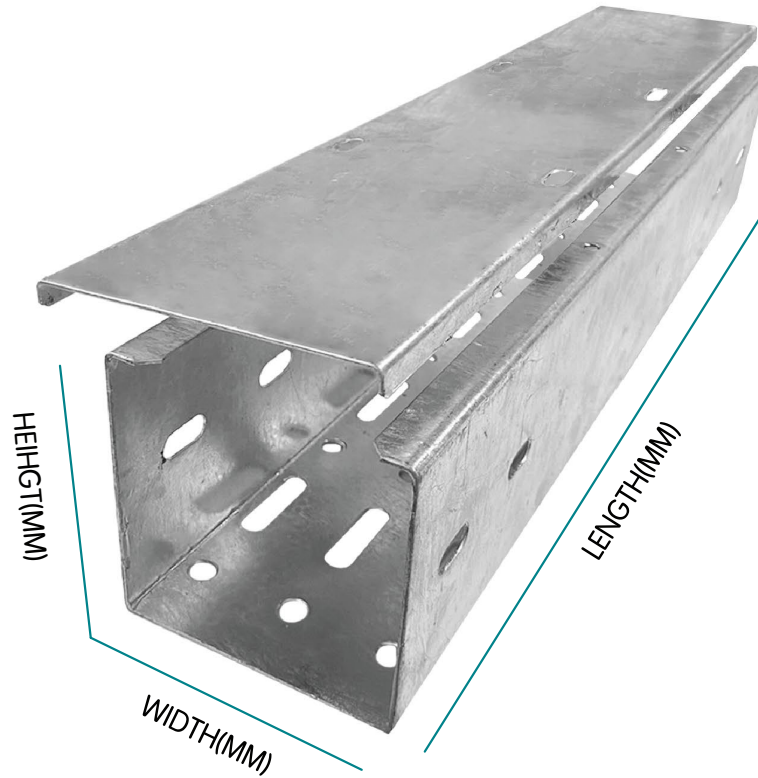

SERIES	WIDTH (MM)	HEIHGT (MM)	LENGTH (MM)
PRT-100x100	100	100	2440
PRT-200x100	200	100	2440
PRT-300x100	300	100	2440
PRT-400x100	400	100	2440
PRT-500x100	500	100	2440
PRT-600x100	600	100	2440
PRT-700x100	700	100	2440
PRT-800x100	800	100	2440
PRT-900x100	900	100	2440
PRT-1000x100	1000	100	2440

PERFORATED TRAY อุปกรณ์รางไฟ

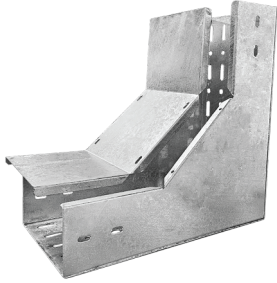

VERTICAL INSIDE
90° โค้งขึ้น (เปิดใน)

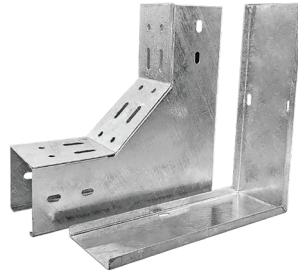

VERTICAL OUTSIDE
90° โค้งขึ้น (เปิดนอก)

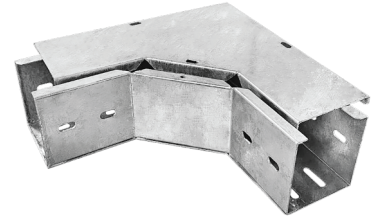

HORIZONTAL BEND
90° ฉาก (เปิดบน)

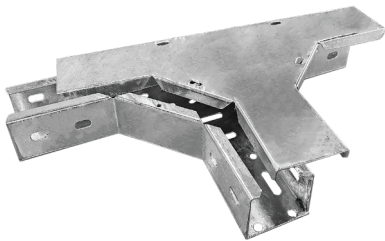

HORIZONTAL TEE
สามทาง

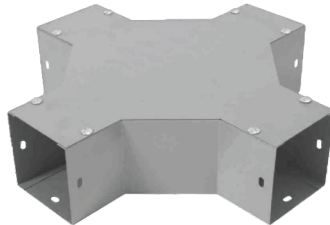

HORIZONTAL CROSS
สี่ทาง

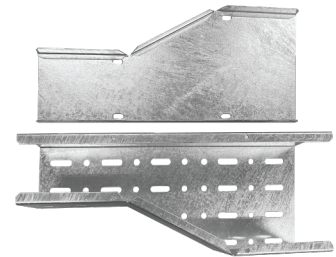

HORIZONTAL REDUCE
ลดไซส์



SPLICE PLATE OUT
ข้อต่อรางไฟ



SPLICE PLATE IN
ข้อต่อรางไฟ



END CAP
ฝาปิดท้ายราง



HOLD DOWN CLAMP
ข้อยึดรางไฟ



ชุดสกรูหัวกลมคอเหลี่ยม
M8x20



น็อตหัวร่มแฉก
M6x10

CABLE TRAY อุปกรณ์วางไฟ

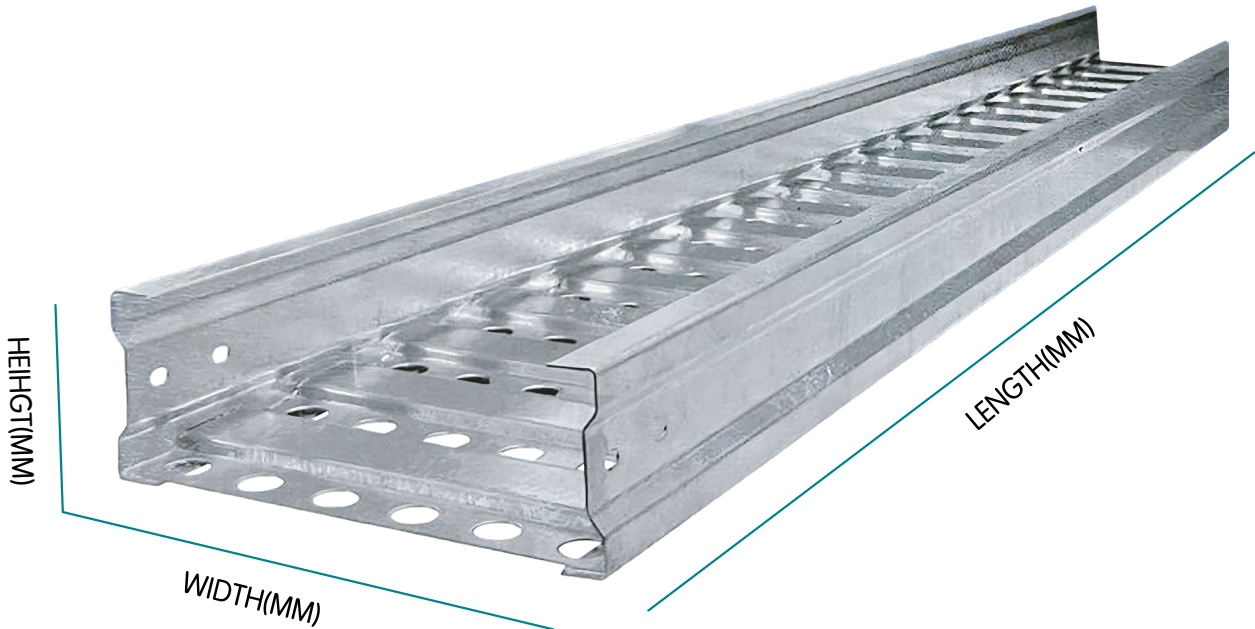

SERIES	WIDTH (MM)	HEIHGT (MM)	LENGTH (MM)
CBT-100x100	100	100	2440
CBT-200x100	200	100	2440
CBT-300x100	300	100	2440
CBT-400x100	400	100	2440
CBT-500x100	500	100	2440
CBT-600x100	600	100	2440
CBT-700x100	700	100	2440
CBT-800x100	800	100	2440
CBT-900x100	900	100	2440
CBT-1000x100	1000	100	2440

CABLE TRAY อุปกรณ์รางไฟ

		
<p>VERTICAL INSIDE 90° โค้งขึ้น (เปิดใน)</p>	<p>VERTICAL OUTSIDE 90° โค้งขึ้น (เปิดนอก)</p>	<p>HORIZONTAL BEND 90° วกฉาก (เปิดบน)</p>
		
<p>HORIZONTAL TEE สามทาง</p>	<p>HORIZONTAL CROSS สี่ทาง</p>	<p>HORIZONTAL REDUCE ลดไซส์</p>
		
<p>SPLICE PLATE OUT ข้อต่อรางไฟ</p>	<p>SPLICE PLATE IN ข้อต่อรางไฟ</p>	<p>END CAP ฝาปิดท้ายราง</p>
		
<p>HOLD DOWN CLAMP ข้อยึดรางไฟ</p>	<p>ชุดสกรูหัวกลมคอเหลี่ยม M8x20</p>	<p>น็อตหัวร่มแฉก M6x10</p>

CABLE LADDER ອຸປະກອນຮາງໄຟ

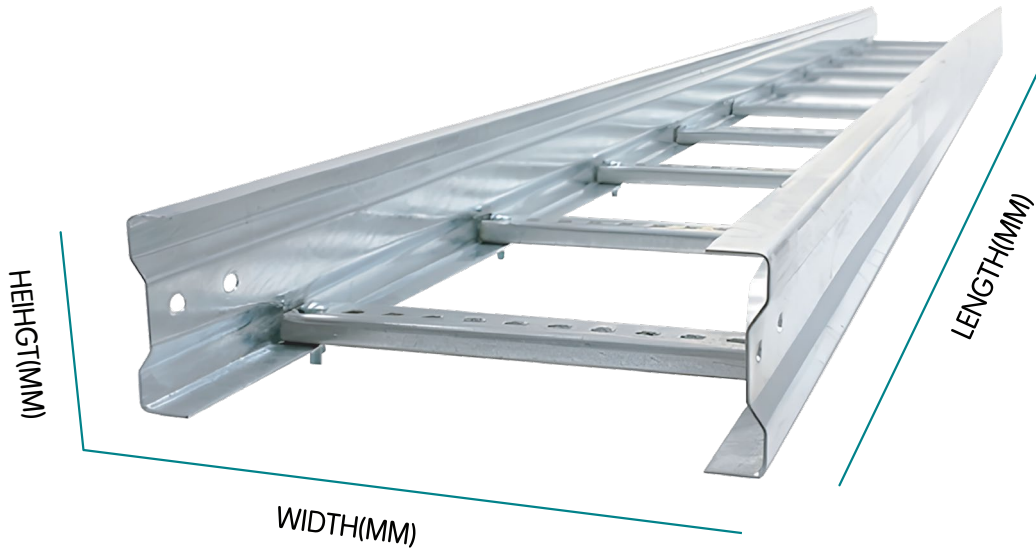

SERIES	WIDTH (MM)	HEIHGT (MM)	LENGTH (MM)
CLD-100x100	100	100	2440
CLD-200x100	200	100	2440
CLD-300x100	300	100	2440
CLD-400x100	400	100	2440
CLD-500x100	500	100	2440
CLD-600x100	600	100	2440
CLD-700x100	700	100	2440
CLD-800x100	800	100	2440
CLD-900x100	900	100	2440
CLD-1000x100	1000	100	2440

CABLE LADDER อุปกรณ์รางไฟ

		
<p>VERTICAL INSIDE 90° โค้งขึ้น (เปิดใน)</p>	<p>VERTICAL OUTSIDE 90° โค้งขึ้น (เปิดนอก)</p>	<p>HORIZONTAL BEND 90° ฉาก (เปิดบน)</p>
		
<p>HORIZONTAL TEE สามทาง</p>	<p>HORIZONTAL CROSS สี่ทาง</p>	<p>CONDUIT CONNECTOR ข้อต่อลงตู้ไฟ</p>
		
<p>SPLICE PLATE OUT ข้อต่อรางไฟ</p>	<p>SPLICE PLATE IN ข้อต่อรางไฟ</p>	<p>END CAP ฝาปิดท้ายราง</p>
		
<p>HOLD DOWN CLAMP ข้อยึดรางไฟ</p>	<p>ชุดสกรูหัวกลมคอเหลี่ยม M8x20</p>	<p>น็อตหัวร่วมแฉก M6x10</p>

ภาพงานติดตั้ง



ภาพงานติดตั้ง



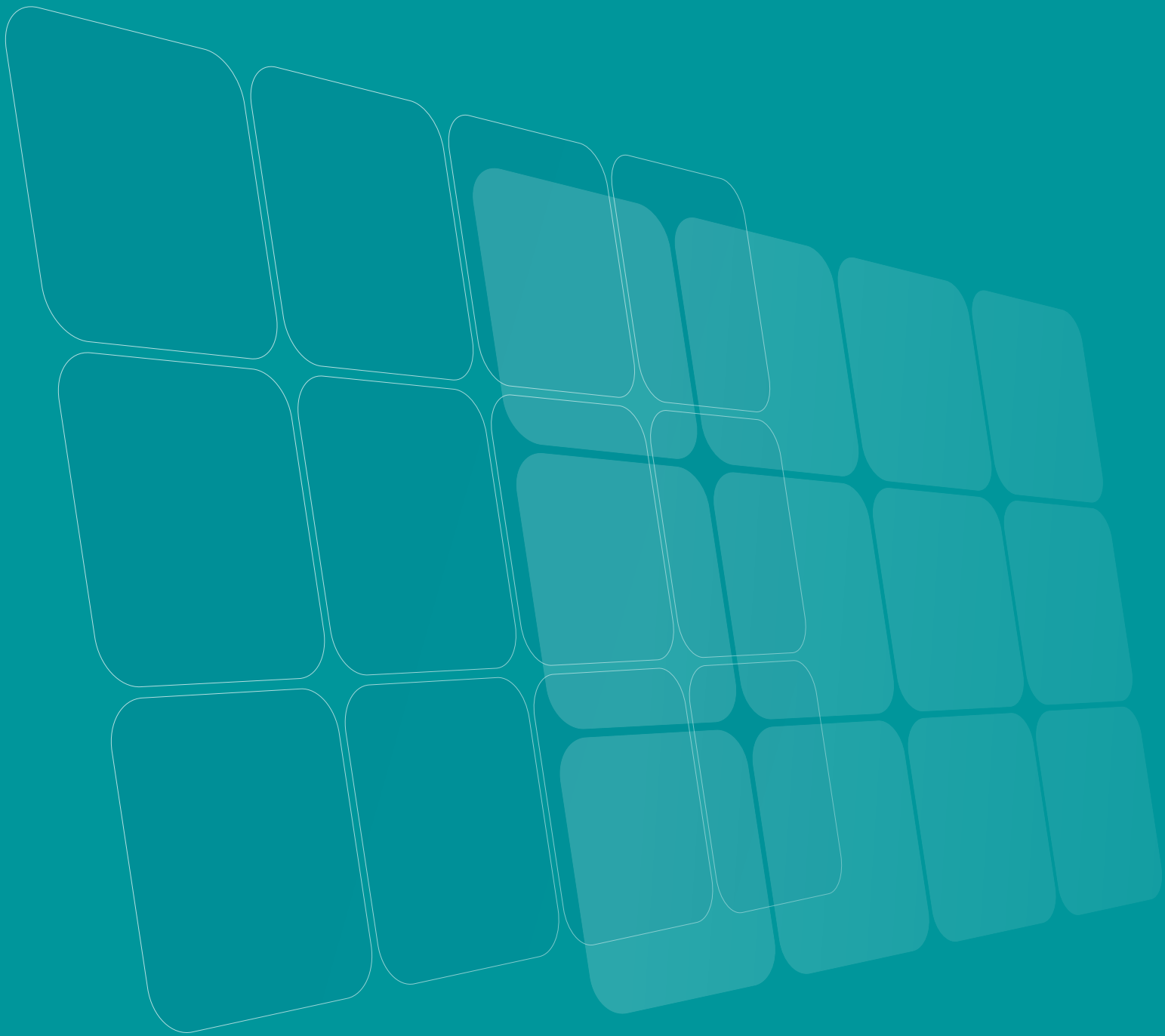

TTP ENERGY CO.,LTD (HEAD OFFICE)

22/154 เพชรเกษม 69 แขวงหนองค้างพลู เขต หนองแขม

กรุงเทพมหานคร 10160 ประเทศไทย

เบอร์โทร : 02 807 4381

มือถือ : 088 022 2727

อีเมล : ttpenergy@gmail.com

เว็บไซต์ : www.ttpenergy.co.th

เลขประจำตัวผู้เสียภาษี 0105559113190