



TTP Energy

- MOUNTING
- WALK WAY
- PERFORATED TRAY
 - CABLE TRAY
 - CABLE LADDER

MOUNTING
อุปกรณ์ติดตั้งโซลาร์เซลล์

2-6

7-8

WALK WAY
ทางเดินโซลาร์เซลล์

SOLAR CELL LIGHT RAIL
อุปกรณ์รางไฟ

9-15

MOUNTING

อุปกรณ์ติดตั้งโซลาร์เซลล์

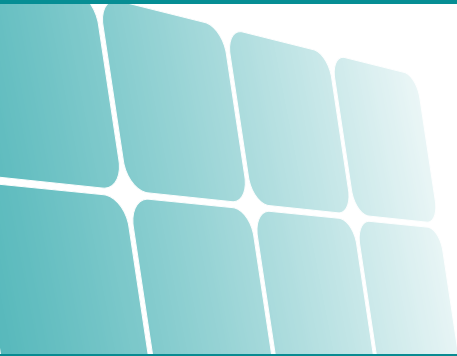

PRICE : 26 ₪



RAIL JOINER SPLCE KIT

STP-M MT-JSK180

Specification

- Suitable for : Pitched roof
- Roof slope : up to 60 degree
- Module orientation : landscape or portrait
- Material : Anodized aluminum 20 um & SUS 304
- Standard Loading (N) 14-20
- Anodized AL6063 -T5

Detail

- Stainless Steel : Socket Head Screw M8x15
- Stainless Steel : Flat Washer M8
- Stainless Steel : Spring Washer M8
- Dimension : W54.8 x H10 x L180 mm.
- Weight Total : 134 g.

PRICE(4200 MM) : 525 ₪
PRICE(4800 MM) : 595 ₪



SOLAR ALU STANDARD RAIL 4200 MM / 4800 MM

STP-F AL -260054200-2

Specification

- Material : Anodized AL6063-T5

Detail

- General Thickness : 1.00 mm
- Dimension : W30 x H58.5 x L4200 mm.
- Weight Total : 2.87 kg.

PRICE(4200 MM) : 510 ₪
PRICE(4800 MM) : 575 ₪



SOLAR ALU STANDARD RAIL 4200 MM / 4800 MM

STP-F AL -260054200-3

Specification

- Material : Anodized AL6063-T5

Detail

- General Thickness : 1.00 mm
- Dimension : W25 x H45 x L4200 mm.
- Weight Total : 2.05 kg.

PRICE : 9 ₪



GROUND STAINLESS PLATE FIX

STP-F GS-GC

Specification

- Material : Stainless Steel 304

Detail

- Dimension : W30 x L32 mm.
- Weight Total : 2.5 g.

PRICE : 6 ₪



CABLE CLIP LOCK

STP-F CBCL

Specification

- Material : Stainless Steel 304

Detail

- Dimension : W18 x L22 x H10 mm.
- Weight Total : 4 g.

PRICE : 55 ฿



ROOF HOOK KLIP LOCK #650 (แบบจีบB)

STP-M AS-RHKL-01

Specification

- Suitable for : Pitched roof
- Roof slope : up to 60 degree
- Module orientation : landscape or portrait
- Material : Anodized aluminum 20 um & SUS 304
- Standard Loading (N) 14-20
- Anodized AL6063-T5

Detail

- Anodized aluminum : Klip Lock #650
- Stainless Steel : Socket Head Screw M8x25
- Stainless Steel : Nylon Lock Nut M8
- Stainless Steel : Spring Washer M8
- Dimension : W25xH58 mm.
- Weight Total : 135 g.

PRICE : 55 ฿



ROOF HOOK KLIP LOCK #700 (แบบโค้งB)

STP-M AS-RHKL-02

Specification

- Suitable for : Pitched roof
- Roof slope : up to 60 degree
- Module orientation : landscape or portrait
- Material : Anodized aluminum 20 um & SUS 304
- Standard Loading (N) 14-20
- Anodized AL6063-T5

Detail

- Anodized aluminum : Klip Lock #700 + With Rubber
- Stainless Steel : Socket Head Screw M8x25
- Stainless Steel : Nylon Lock Nut M8
- Stainless Steel : Spring Washer M8
- Dimension : W37xH63.5 mm.
- Weight Total : 155 g.

PRICE : 30 ฿



MID CLAMP 35MM (M8x45 MM.)

STP-M MT-MCSW35

Specification

- Suitable for : Pitched roof
- Roof slope : up to 60 degree
- Module orientation : landscape or portrait
- Material : Anodized aluminum 20 um & SUS 304
- Standard Loading (N) 14-20
- Anodized AL6063-T5

Detail

- Stainless Steel : Socket Head Screw M8x45
- Stainless Steel : T Nut Lock M8
- Stainless Steel : Spring Washer M8
- Stainless Steel : Flat Washer M8
- Dimension : W45xD40 mm.
- Weight Total : 54 g.

PRICE : 34 ฿



EARTHING KIT

STP-M AS -EK

Specification

- Suitable for : Pitched roof
- Roof slope : up to 60 degree
- Module orientation : landscape or portrait
- Material : Anodized aluminum 20 um & SUS 304
- Standard Loading (N) 14-20
- Anodized AL6063-T5

Detail

- Stainless Steel : Socket Head Screw M8x25
- Stainless Steel : T Nut Lock M8
- Stainless Steel : Spring Washer M8
- Stainless Steel : Flat Washer M8
- Stainless Steel : Hex Bolt M5x15
- Dimension : W20xL45 mm.
- Weight Total : 41 g.

PRICE : 26.50 ฿

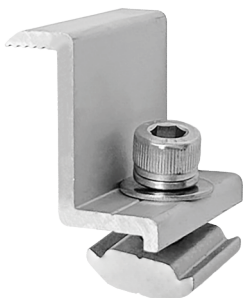

END CLAMP 30/35 MM

STP-M MT-ECA-H35

Specification

- Suitable for : Pitched roof
- Roof slope : up to 60 degree
- Module orientation : landscape or portrait
- Material : Anodized aluminum 20 um & SUS 304
- Standard Loading (N) 14-20
- Anodized AL6063-T5

Detail

- Stainless Steel : Socket Head Screw M8x25
- Stainless Steel : T Nut Lock M8
- Stainless Steel : Spring Washer M8
- Stainless Steel : Flat Washer M8
- Dimension : W40xH30/35 mm.
- Weight Total : 45 g.

PRICE : 110 ₪



SOLAR SUS304 TILE HOOK M10-200

STP-M MT-THM 10-200

Specification

- Suitable for : Pitched roof
- Roof slope : up to 60 degree
- Module orientation : landscape or portrait
- Material : Anodized aluminum 20 um & SUS 304
- Standard Loading (N) 14-20
- Anodized AL6063-T5

Detail

- Stainless Steel : Hanger Bolt M10x200
- Stainless Steel : T Nut Lock M8t
- Stainless Steel : Spring Washer M8
- Stainless Steel : Flat Washer M8
- Dimension : L Feet L40 x H85 x 8.5 mm
- Weight Total : 224g.

PRICE : 100 ₪



SOLAR ALUMINUM HOOK METAL SHEET

STP-M MT-AHMS

Specification

- Suitable for : Pitched roof
- Roof slope : up to 60 degree
- Module orientation : landscape or portrait
- Material : Anodized aluminum 20 um & SUS 304
- Standard Loading (N) 14-20
- Anodized AL6063-T5

Detail

- Stainless Steel : Socket Head Screw M8x25
- Self Drilling Screw Hex Washer + With Rubber
- Stainless Steel : T Nut Lock M8
- Stainless Steel : Spring Washer M8
- Stainless Steel : Flat Washer M8
- Dimension : L Feet L35 x H85 x 8.5 mm
- Weight Total : 118 g.

PRICE : 70 ₪



SOLAR L-BACKING H 16 CM

SSTP-GMT-L-BK9-H16

Specification

- Suitable for : Pitched roof
- Roof slope : up to 60 degree
- Module orientation : landscape or portrait
- Material : Anodized aluminum 20 um & SUS 304
- Standard Loading (N) 14-20
- Anodized AL6063-T5

Detail

- Dimension : W40xH160 mm.
- Weight Total : 54g.

PRICE : 150 ₪



SOLAR SUS304 TILE HOOK/CPAC

STP-M MT-TH/CPAC

Specification

- Suitable for : Pitched roof
- Roof slope : up to 60 degree
- Module orientation : landscape or portrait
- Material : Anodized aluminum 20 um & SUS 304
- Standard Loading (N) 14-20
- Stainless Steel 304

Detail

- Stainless Steel : Socket Head Screw M8x20
- Self Drilling Screw Hex Washer + With Rubber
- Stainless Steel : T Nut Lock M8
- Stainless Steel : Spring Washer M8
- Stainless Steel : Flat Washer M8
- Dimension : 54.8x102.2x162.7 mm
- Weight Total : 567 g.

PRICE : 19 ₪



T NUT WITH BOLT FOR HOOK 15/20/25/60

STP-M MT-TNBH

Specification

- Material : Stainless Steel 304

Detail

- Stainless Steel : Socket Head Screw M8x15/20/25/60
- Stainless Steel : T Nut Lock M8
- Stainless Steel : Spring Washer M8
- Stainless Steel : Flat Washer M8
- Weight Total : 12/15/17/28 g.

PRICE(6 MM) : 10 ₪
PRICE(8 MM) : 15 ₪



ALUMINIUM FERRULE 6MM./ 8MM.

STA-F ALU FERRULE8

PRICE(6 MM) : 20 ₪
PRICE(8 MM) : 25 ₪



STAINLESS STEEL WIRE ROPE THIMBLE 6MM./ 8MM.

STP-F SWT-8

PRICE(6 MM) : 26 ₪
PRICE(8 MM) : 32 ₪



STAINLESS STEEL WIRE ROPE CLIP 6MM./ 8MM.

STP-F SWC-8

PRICE(6 MM) : 60 ₪
PRICE(8 MM) : 75 ₪



STAINLESS STEEL TURNBUCKLES 6MM./ 8MM.

STP-F TBG-SIZE 8 mm

PRICE(6 MM) : 44 ₪/m
PRICE(8 MM) : 65 ₪/m

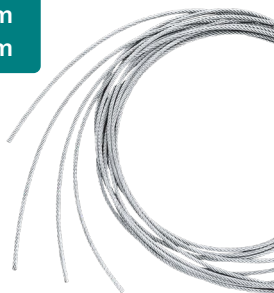

STAINLESS STEEL WIRE ROPE 6MM./ 8MM.

STP-F SWR-8

PRICE(1000X30 MM) : 967 ₪



LIFELINE SAFETY STEEL POLE 1000X30 MM. BASE 500X30 MM.HDG & STAINLESS STEEL 304 (UP TO YOU TO ORDER THE SIZE)

STP-M LLS 100030x50030HDG

WALK WAY

ทางเดินโซล่าเซลล์

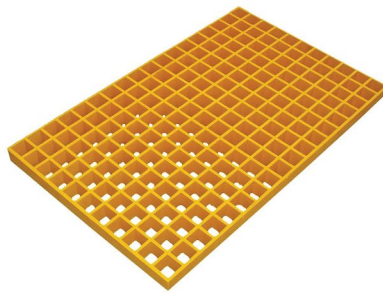
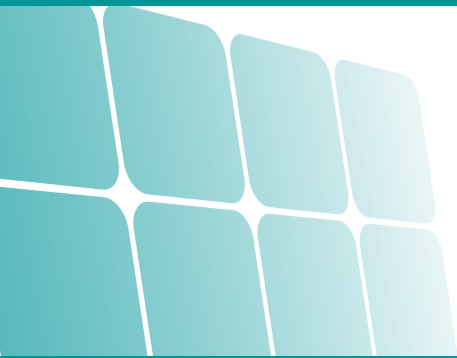

WALK WAY ทางเดินโซล่าเซลล์

แผงตะแกรงขึ้นรูปไฟเบอร์กลาส Fiber Mode Grating Panel พลาสติกไฟเบอร์ ผลิตด้วยกระบวนการขึ้นรูปพิเศษ ด้วยแม่พิมพ์ทำจากเรซินโพลีเอสเตอร์ไม่อิ่มตัว ไวนิลเอสเตอร์และฟอนอลิก วัสดุรูปจากเป็นเมทริกซ์ทำด้วยแก้วที่มี ฤทธิ์ต้านปานกลาง ไปจนถึงปราศจากด่าง แข็งแรง ทนทานต่อทุกสภาพอากาศ

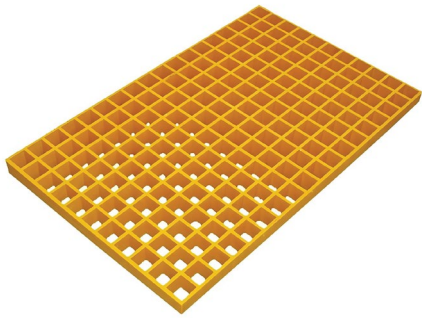

WALK WAY FIBERGLASS

STP-F WFG

Detail

- Materrail : Fiber mode grating panel
- Dimension : 390x25x4020 mm.



WALKWAY CLAMP LOCK M-CLIP M8x25MM

STP-M WCL-M CL M8x25MM

Detail

- Materrail : Stainless Steel 304W50 x H20 mm.
- Dimension : W50 x H20 mm.
- Weight Total : 120 g.



WALKWAY CLAMP LOCK C-CLIP M8x30MM

STP-M WCL-C CL M8x30MM

Detail

- Materrail : Stainless Steel 304
- Dimension : W35 x H30 mm.
- Weight Total : 119 g.

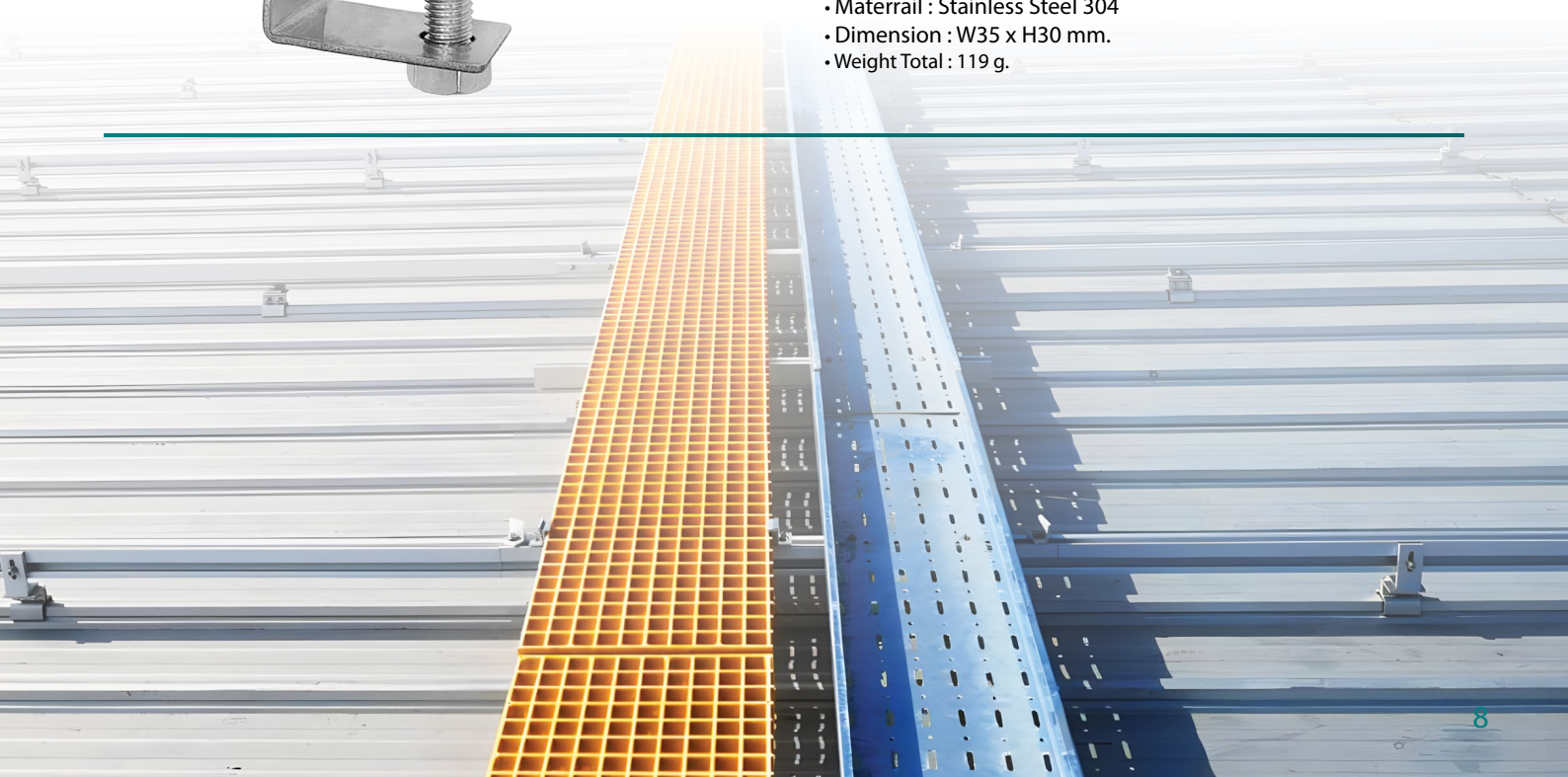

SOLAR CELL LIGHT RAIL

อุปกรณ์รางไฟ

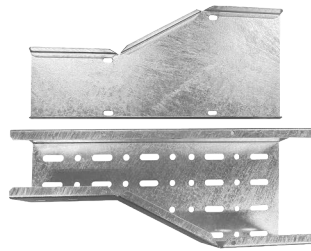
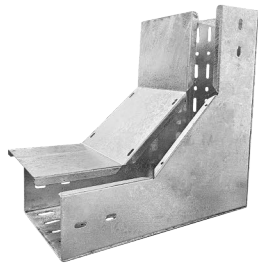
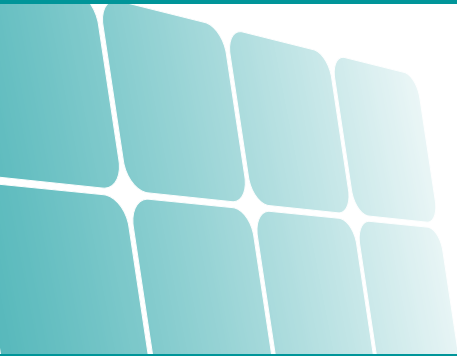

PERFORATED TRAY ອຸປະກອນຮາງໄຟ

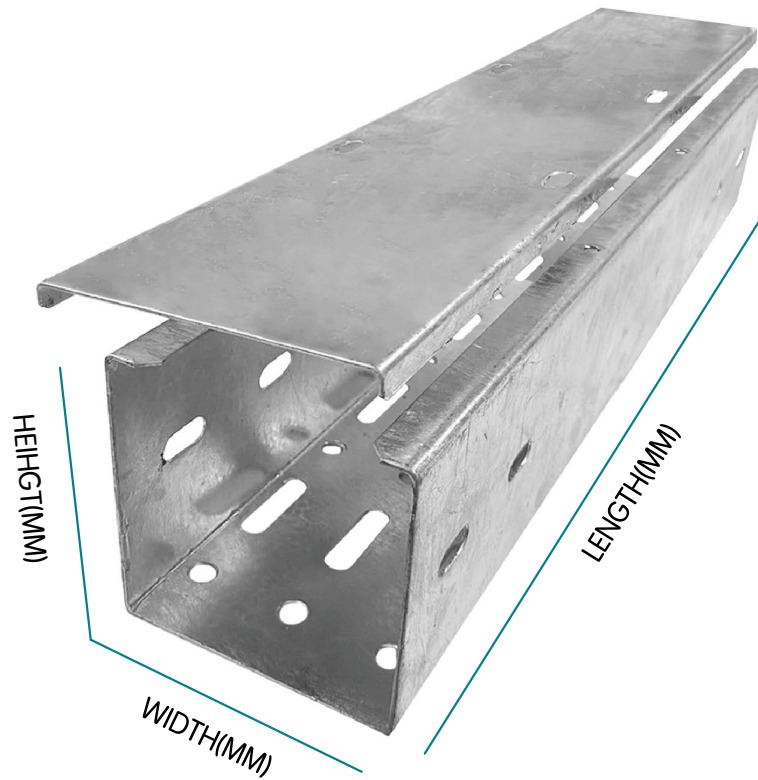

SERIES	WIDTH (MM)	HEIHGT (MM)	LENGTH (MM)
PRT-100x100	100	100	2440
PRT-200x100	200	100	2440
PRT-300x100	300	100	2440
PRT-400x100	400	100	2440
PRT-500x100	500	100	2440
PRT-600x100	600	100	2440
PRT-700x100	700	100	2440
PRT-800x100	800	100	2440
PRT-900x100	900	100	2440
PRT-1000x100	1000	100	2440

PERFORATED TRAY อุปกรณ์รางไฟ

		
<p>VERTICAL INSIDE 90° โค้งขึ้น (เปิดใน)</p>	<p>VERTICAL OUTSIDE 90° โค้งขึ้น (เปิดนอก)</p>	<p>HORIZONTAL BEND 90° จอฉาก (เปิดบน)</p>
		
<p>HORIZONTAL TEE สามทาง</p>	<p>HORIZONTAL CROSS สี่ทาง</p>	<p>HORIZONTAL REDUCE ลดไซส์</p>
		
<p>SPLICE PLATE OUT ข้อต่อรางไฟ</p>	<p>SPLICE PLATE IN ข้อต่อรางไฟ</p>	<p>END CAP ฝาปิดท้ายราง</p>
		
<p>HOLD DOWN CLAMP ข้อยึดรางไฟ</p>	<p>ชุดสกรูหัวกลมคอเหลี่ยม M8x20</p>	<p>น็อตหัวร่วมแฉก M6x10</p>

CABLE TRAY อุปกรณ์วางไฟ

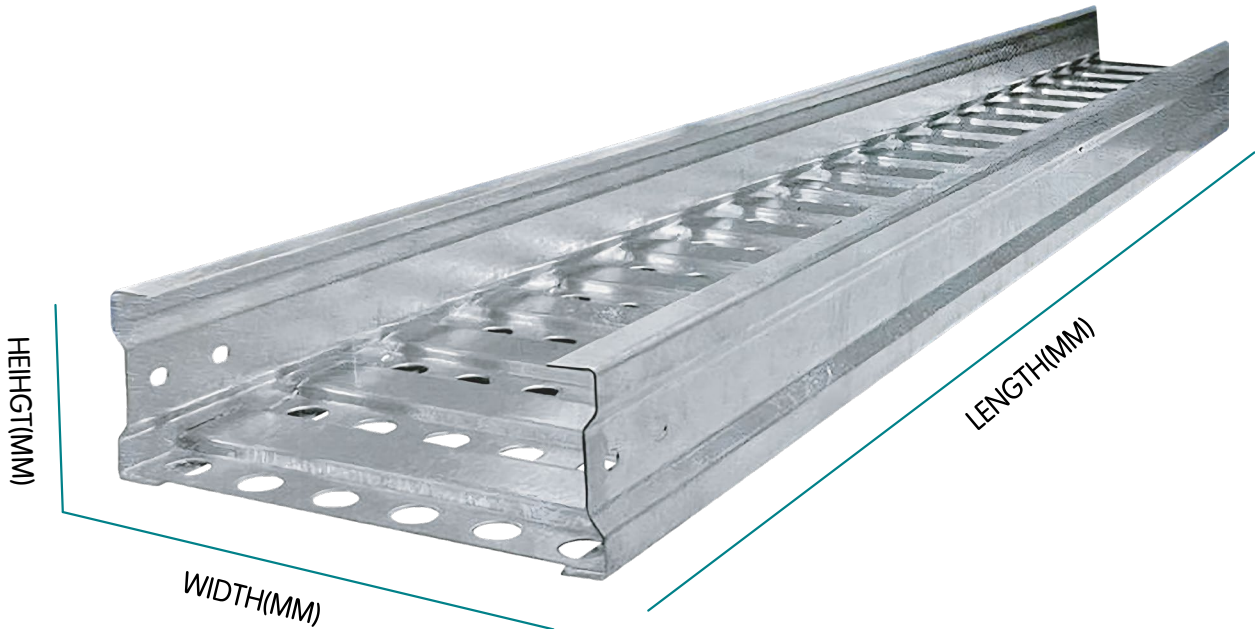

SERIES	WIDTH (MM)	HEIHGT (MM)	LENGTH (MM)
CBT-100x100	100	100	2440
CBT-200x100	200	100	2440
CBT-300x100	300	100	2440
CBT-400x100	400	100	2440
CBT-500x100	500	100	2440
CBT-600x100	600	100	2440
CBT-700x100	700	100	2440
CBT-800x100	800	100	2440
CBT-900x100	900	100	2440
CBT-1000x100	1000	100	2440

CABLE TRAY อุปกรณ์รางไฟ

		
<p>VERTICAL INSIDE 90° โค้งขึ้น (เปิดใน)</p>	<p>VERTICAL OUTSIDE 90° โค้งขึ้น (เปิดนอก)</p>	<p>HORIZONTAL BEND 90° วกฉาก (เปิดบน)</p>
		
<p>HORIZONTAL TEE สามทาง</p>	<p>HORIZONTAL CROSS สี่ทาง</p>	<p>HORIZONTAL REDUCE ลดไซส์</p>
		
<p>SPLICE PLATE OUT ข้อต่อรางไฟ</p>	<p>SPLICE PLATE IN ข้อต่อรางไฟ</p>	<p>END CAP ฝาปิดท้ายราง</p>
		
<p>HOLD DOWN CLAMP ข้อยึดรางไฟ</p>	<p>ชุดสกรูหัวกลมคอเหลี่ยม M8x20</p>	<p>น็อตหัวร่วมแฉก M6x10</p>

CABLE LADDER ອຸປະກອນຮາງໄຟ

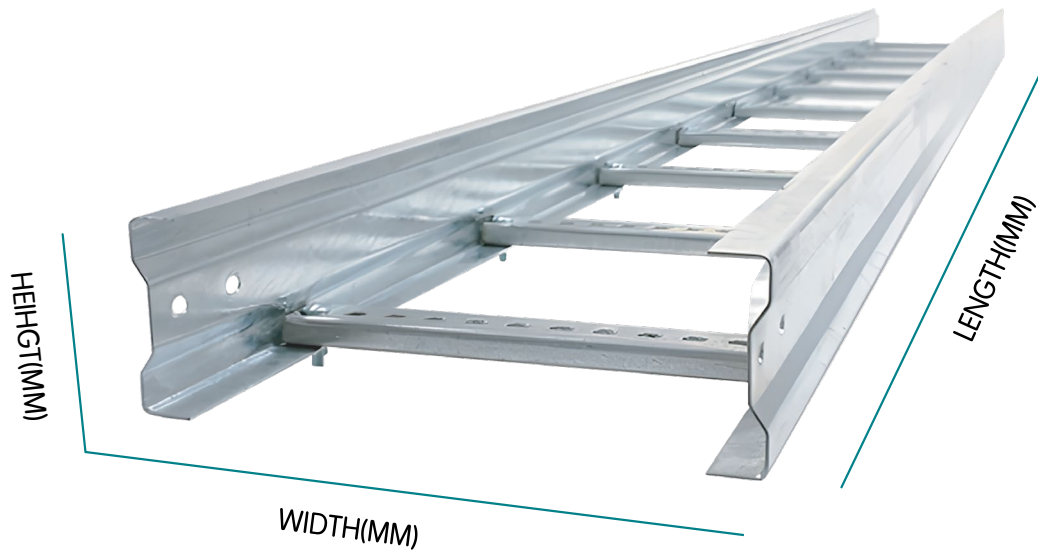

SERIES	WIDTH (MM)	HEIHGT (MM)	LENGTH (MM)
CLD-100x100	100	100	2440
CLD-200x100	200	100	2440
CLD-300x100	300	100	2440
CLD-400x100	400	100	2440
CLD-500x100	500	100	2440
CLD-600x100	600	100	2440
CLD-700x100	700	100	2440
CLD-800x100	800	100	2440
CLD-900x100	900	100	2440
CLD-1000x100	1000	100	2440

CABLE LADDER อุปกรณ์รางไฟ

		
<p>VERTICAL INSIDE 90° โค้งขึ้น (เปิดใน)</p>	<p>VERTICAL OUTSIDE 90° โค้งขึ้น (เปิดนอก)</p>	<p>HORIZONTAL BEND 90° ฉาก (เปิดบน)</p>
		
<p>HORIZONTAL TEE สามทาง</p>	<p>HORIZONTAL CROSS สี่ทาง</p>	<p>CONDUIT CONNECTOR ข้อต่อลงตู้ไฟ</p>
		
<p>SPLICE PLATE OUT ข้อต่อรางไฟ</p>	<p>SPLICE PLATE IN ข้อต่อรางไฟ</p>	<p>END CAP ฝาปิดท้ายราง</p>
		
<p>HOLD DOWN CLAMP ข้อยึดรางไฟ</p>	<p>ชุดสกรูหัวกลมคอเหลี่ยม M8x20</p>	<p>น็อตหัวร่วมแฉก M6x10</p>

ภาพงานติดตั้ง



ภาพงานติดตั้ง





TTP ENERGY CO.,LTD (HEAD OFFICE)

22/154 เพชรเกษม 69 แขวงหนองค้างพลู เขต หนองแขม

กรุงเทพมหานคร 10160 ประเทศไทย

เบอร์โทร : 02 807 4381

มือถือ : 088 022 2727

อีเมล : ttpenergy@gmail.com

เว็บไซต์ : www.ttpenergy.co.th

เลขประจำตัวผู้เสียภาษี 0105559113190